

PRODUCT SHEET / 2020 03 13

JungleWall

Wall absorbent

Design: Superlab



GLIMAKRA
OFSWEDEN



JungleWall

Wall absorbent

Design: Superlab

JungleWall is a series of sound absorbing leaves in different patterns. The leaves are made of felt and mounted in a way that creates a distance to the wall which is a good condition for sound absorption. JungleWall is advantageously used in large quantities in a workplace or public environment as a background wall.

DIMENSIONS

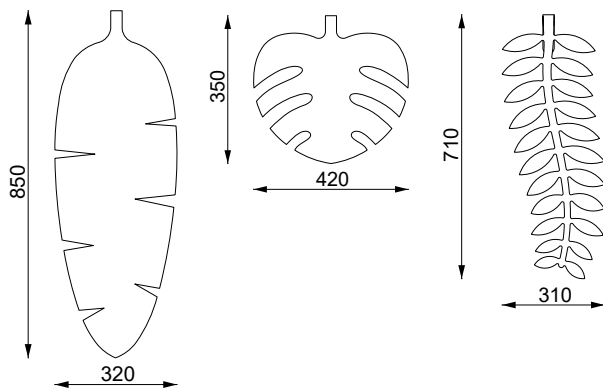

Banana Leaf

3 different leaves.

Thickness: 5 mm

Weight: 800 g/m² (appr. 100 g/leaf)

100% recyclable material.

Deliveres in 6-pack/leaf.

Complete with fittings.

Monstera

Royal Fern

OPTIONS

For suspension there are:

- Stained hook in solid ash.
- Black bioplastics clips (Biodolomer®)
- Round bar in solid ash, ø 30 mm, length: 1300 mm, 1900 mm, 2500 mm, 3100 mm. 2 wires with loops per round bar c/c 600 mm. We recommend ordering more leaves for stand-alone suspension with a round rod as you can hang leaves on both sides.

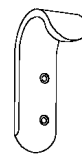

Hook

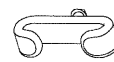

Clips

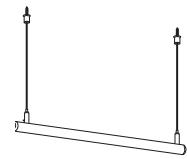

Round bar

DESCRIPTION

Leaf: 5 mm polyester felt

Suspension: hook in solid ash or clips and round bar

Mounting: Leaf and hook screwed directly onto wall. Round bar is hung with wire in the ceiling.

FELT

Green standard colours 446, 447, 448.

Other colours on request (see page 4).



446



447



448

Photographic felt scans are displayed as a guide and colour variations may occur. If needed, we advise you request actual felt samples before ordering.

JungleWall

Wall absorbent

Design: Superlab



CERTIFICATES

Measurements made in accordance with ISO 354:2003, 2019-04-08. Evaluation made according to standard for individual objects SS 25269:2013 (Report: 19-709-M8 and 19-709-M7) and ISO 11654:1997 (Report: 19-709-M9).

$a_w = 0,55$ (MH), Absorption class D

N_{10} : 1,7 (10,79 m. 28 pcs assembly square)

N_{10} : 9,1 (1,54 m. 4 pcs assembly square)

Glimakra of Sweden AB is certified according to ISO 9001:2015 and ISO 14001:2015.



Fire Reaction

- EN 13501-1+A1: B-s1, d0
- ASTM E-84-18: Class A

Abrasion resistance

- UNE-EN 14465+A1: Class A
- ISO 12947- 2 / AC: > 50.000 rubs cycles Martindale

Colour fastness to light

- EN ISO 105-B02: 6-7

STANDARD 100 by OEKO-TEX®

SPECIFICATION TEXT

Eg: JungleWall wall absorbent in felt. Suspension with hook in solid ash.

6 pcs Banana Leaf green 448

6 pcs Monstera green 448

6 pcs Royal Fern green 448

JungleWall $a_w = 0,55$ (MH)

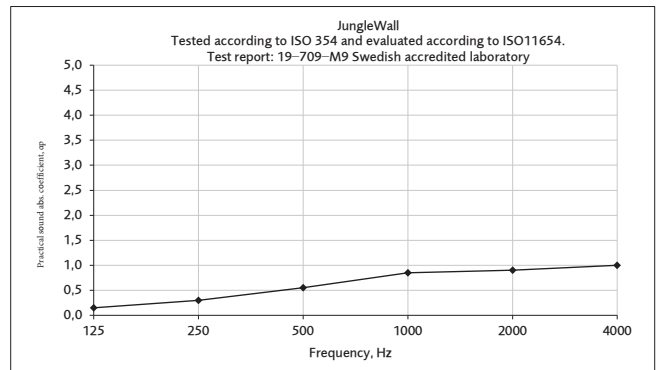

Equivalent absorption area per m^2 (m^2S/m^2)

JungleWall 4 squares ($1,54 m^2$) $N_{10} = 9.1$

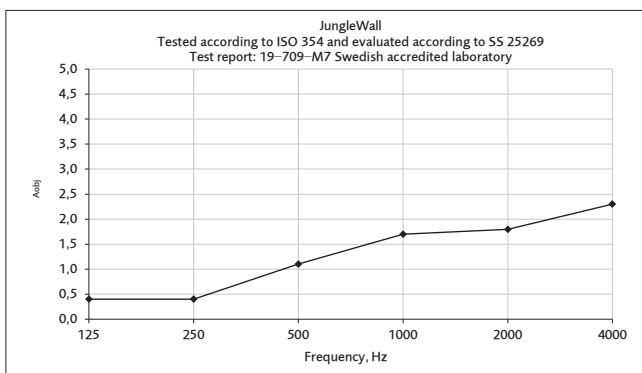

Equivalent absorption area per object ($m^2S/object$)

JungleWall 28 squares ($10,79 m^2$) $N_{10} = 1.7$

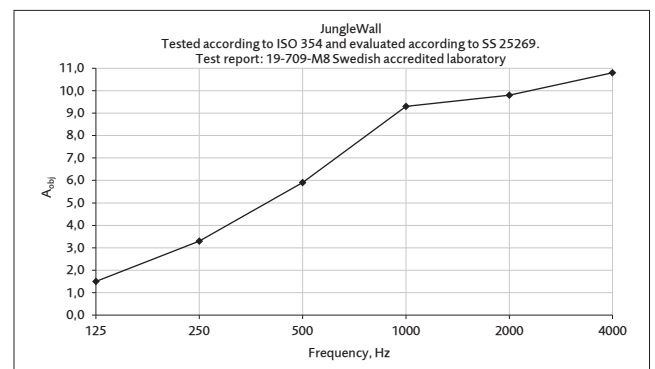

Equivalent absorption area per object ($m^2S/object$)

JungleWall

Wall absorbent

Design: Superlab



COLOURS ON REQUEST

The felt in these colours is not available in stock, delivery time on request. Min. order quantity of 8 packages (48 leaves) / colour.

Photographic felt scans are displayed as a guide and colour variations may occur. If needed, we advise you request actual felt samples before ordering.



401

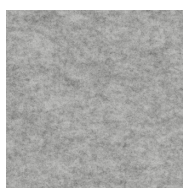

401 ML

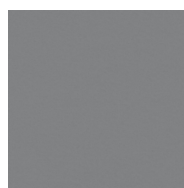

494

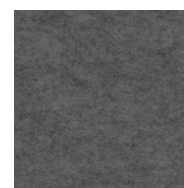

494 ML



499

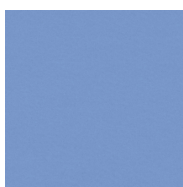

450



450 ML



456



446 ML

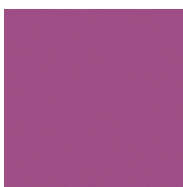

432



432 ML



424

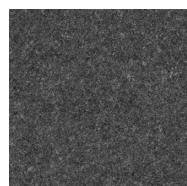

496 ML



424 ML



423 ML

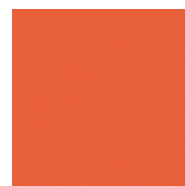

426



426 ML



438



438 ML

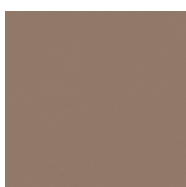

409



409 ML

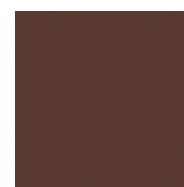

478

JungleWall

Wall absorbent

Design: Superlab



ASSEMBLY EXAMPLE WITH HOOK

In the template there are 5 leaves per 600 x 600 mm. (~ 13,8 leaves/m²)

2 Banana leaves, 2 Monstera and 1 Royal Fern.

This is repeated sideways. When repeating upwards, the template is moved 300 mm.

1. Mounting starts down to the left 440 mm above the floor. (Level 1)
2. Mark attachment points on the wall according to the dimensioning. (Level 1)
3. The attachment points are copied with c/c 600 mm to the right. (Level 1)
4. The next height is placed c/c 600 mm and offset 300 mm to the right. (Level 2)
5. Level 3 is copied with c/c 1200 mm from level 1. (Level 3)

