

Onde Floating Installation Guide

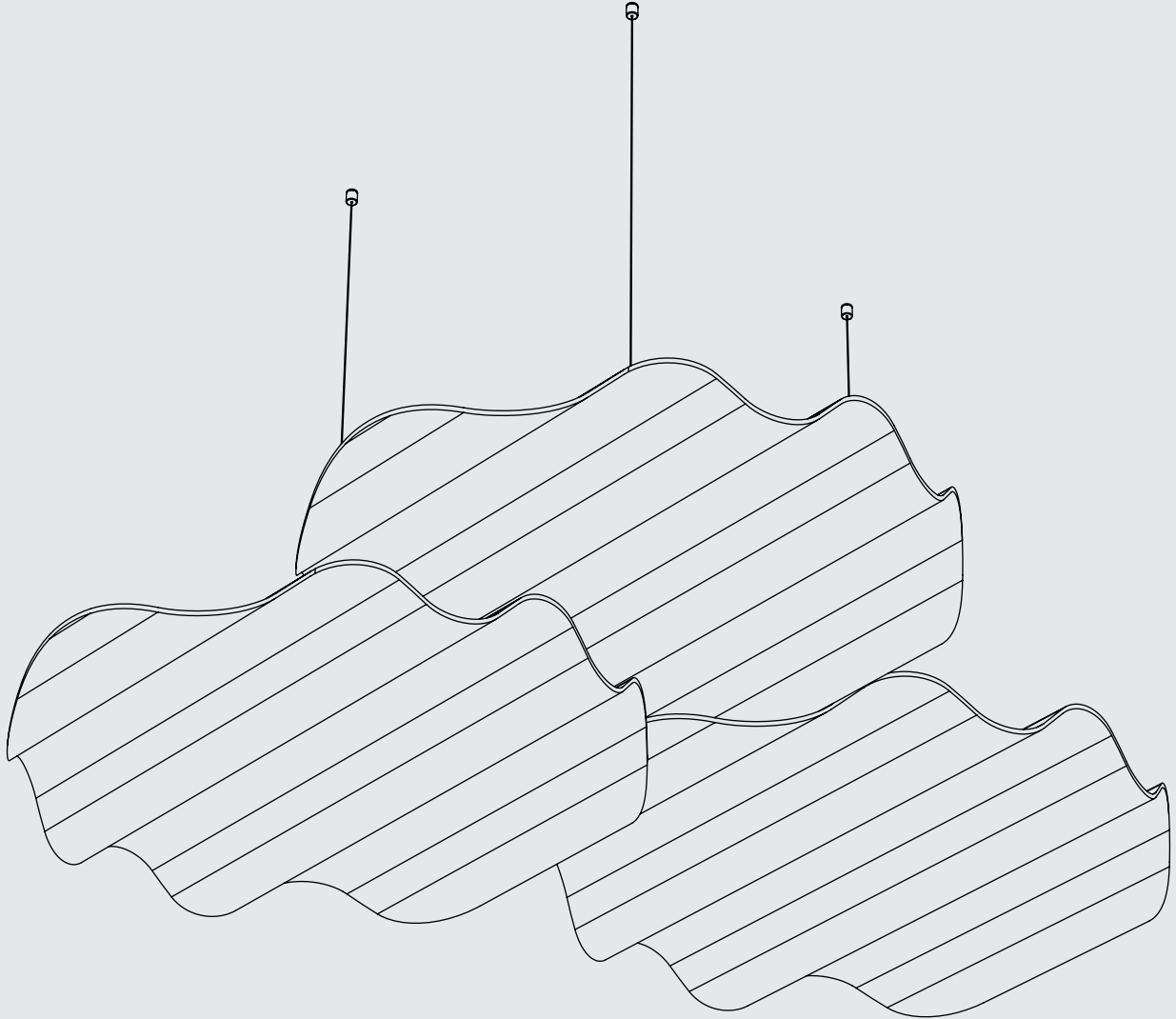

DeVorm

Tools

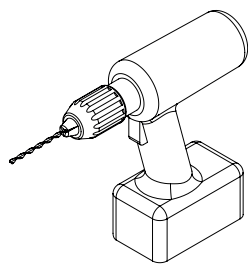

Drill
Ø6 mm

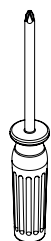

Screwdriver
PH2

Mounting parts

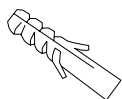

Wall plug
Ø6x30mm
3x



Screws
PZ 4X35 mm
3x

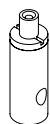

Adjuster
3x



Screws
M4X10
3x

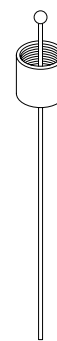

Ceiling mount
Ø11x14 mm
3x

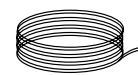

Steel cable
Ø1x3 m
2x

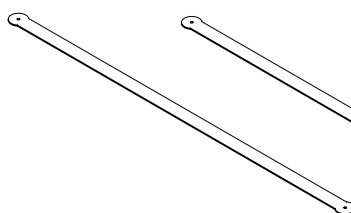

Strip
750 mm
L

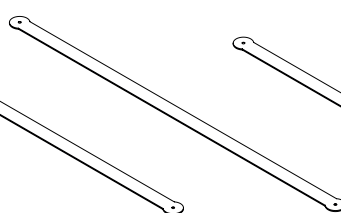

Strip
727 mm
M

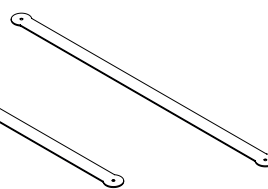

Strip
570 mm
S

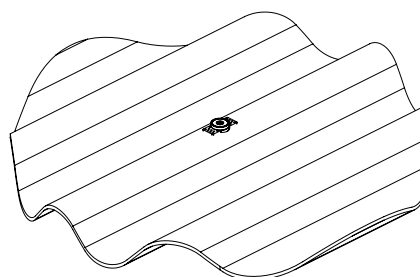

Onde
3x

1 Take the strips

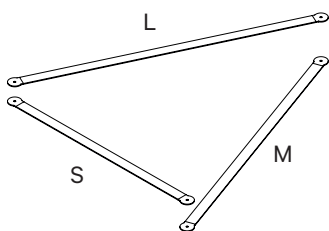

2 Assemble the triangle

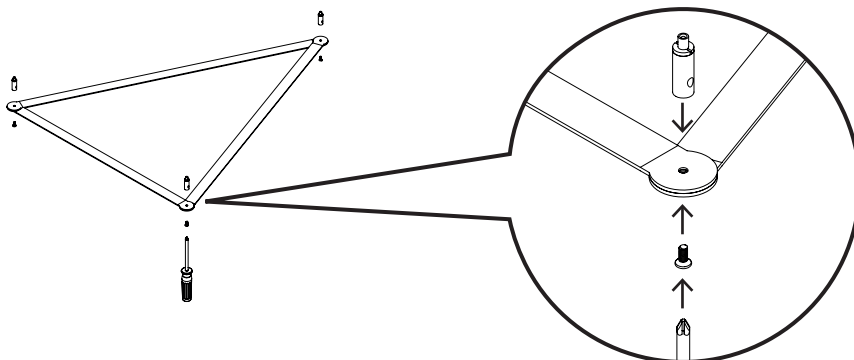

3 Drill holes in the ceiling

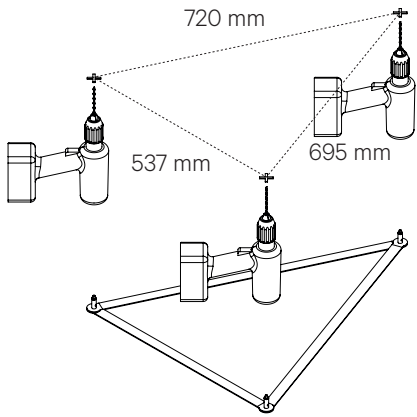

4 Install the ceiling cap and connect the steel wires to the triangle

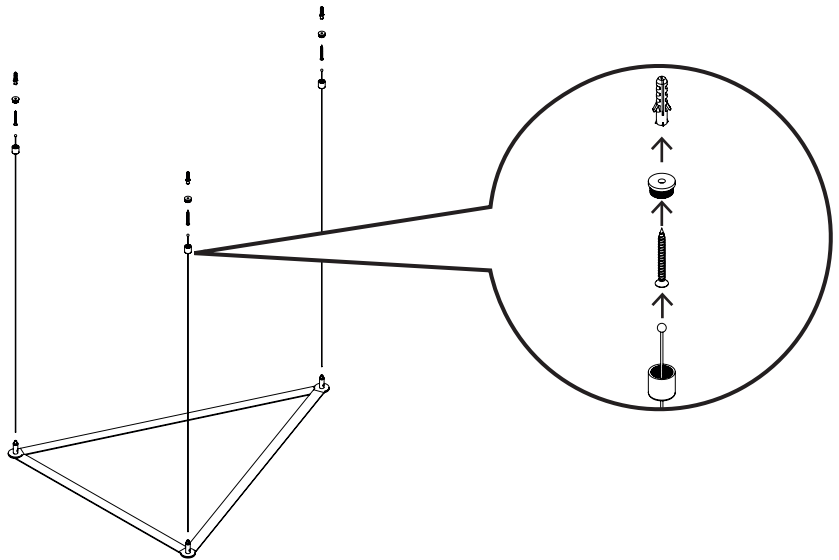

5 Snap Onde to the triangle, using the magnets

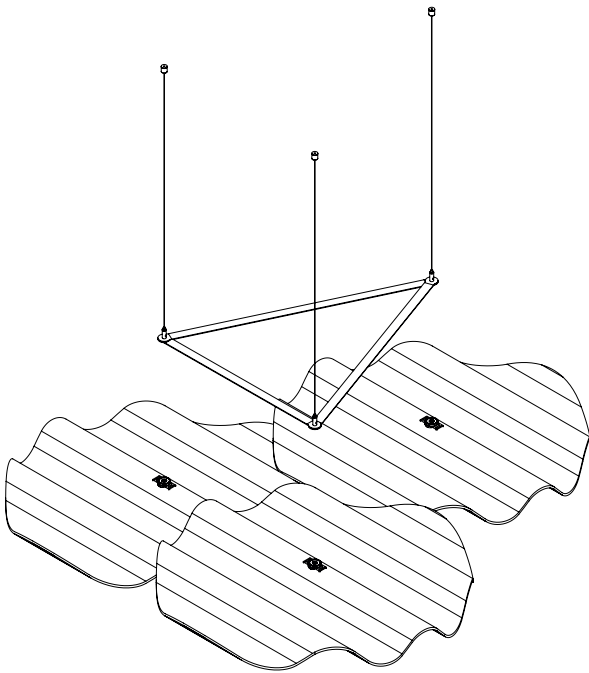

6 Congratulations, it's done!

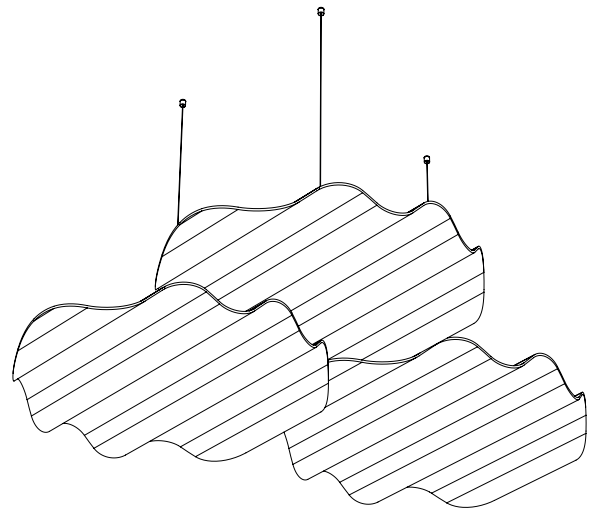

7 Optional: grid for larger installations

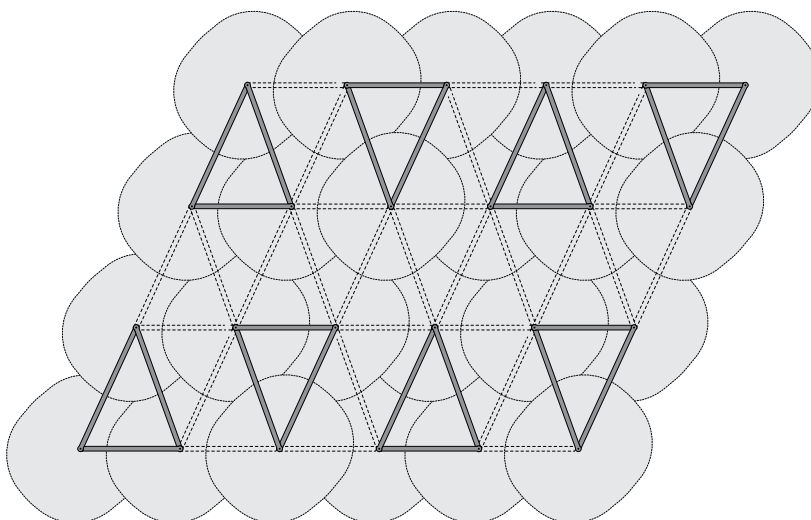

We create interior products by today's standards.

De Vorm is established in a new era, we develop products by the standards of today. This means we produce efficiently, use the full lifecycle of products and eventually give them a new life.

Our emphasis lies on making a product that works, by setting a variety of conditions; it should be legible, accessible, but also environmental friendly and aesthetically perfectly in balance.

We like a product because of its functionality.

A good product makes life easier — by helping us function better throughout the day. We firmly believe that the beauty of a design lies in the sum of its functions. That is what makes it a complete product.

We continuously raise the bar.

From the very first sketches we already start searching, combining and developing new techniques to find new possibilities to innovate. Our design process is infused with technical development; techniques result in aesthetic features and the other way round.



Onde

Acoustic wall panel

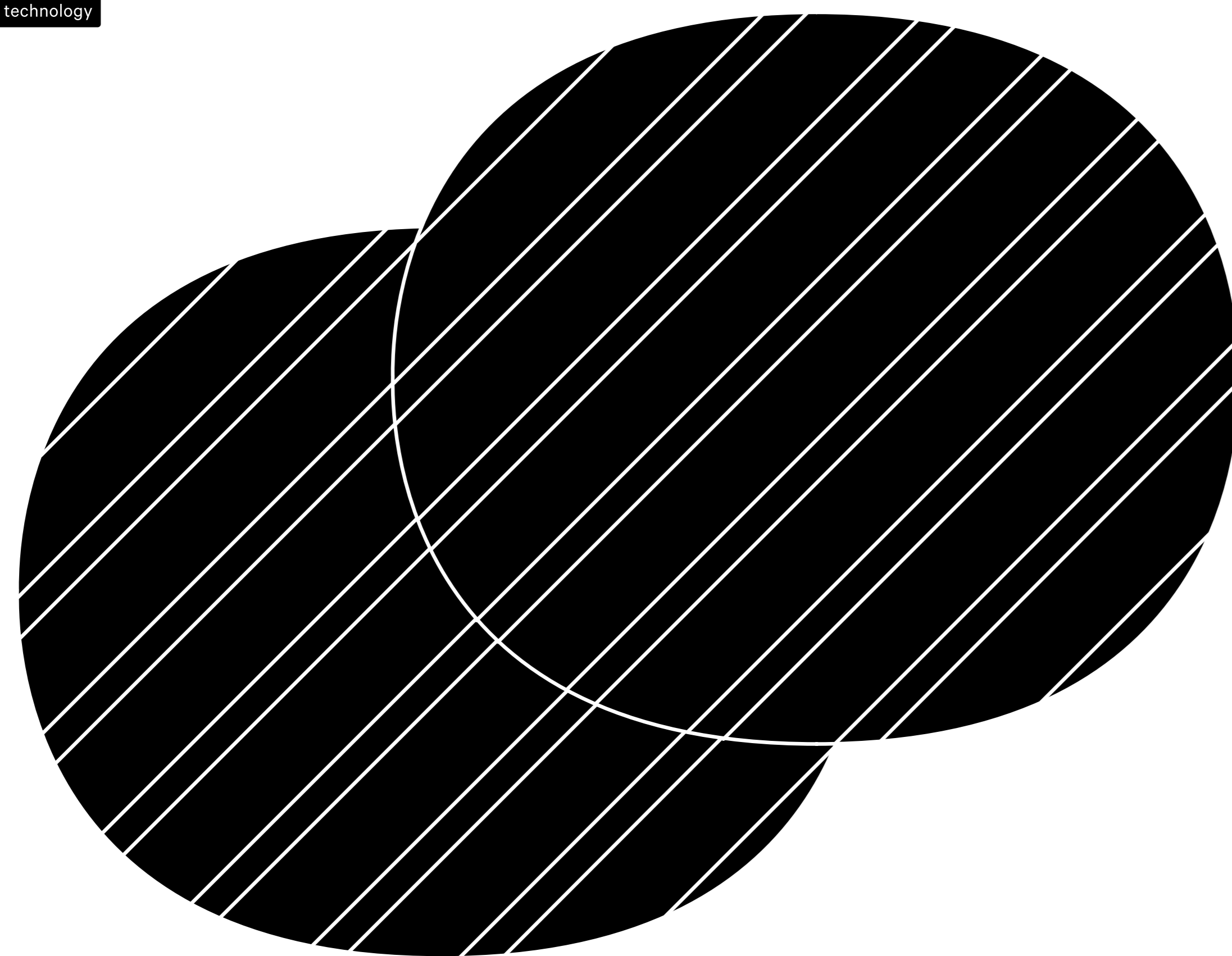

Designer
Perrine Vigneron

The aesthetic take on an acoustic panel without compromising on sound dampening qualities. The panel is pressed from PET felt and it's design allows free placement and overlapping to create a unique composition.

Configuration

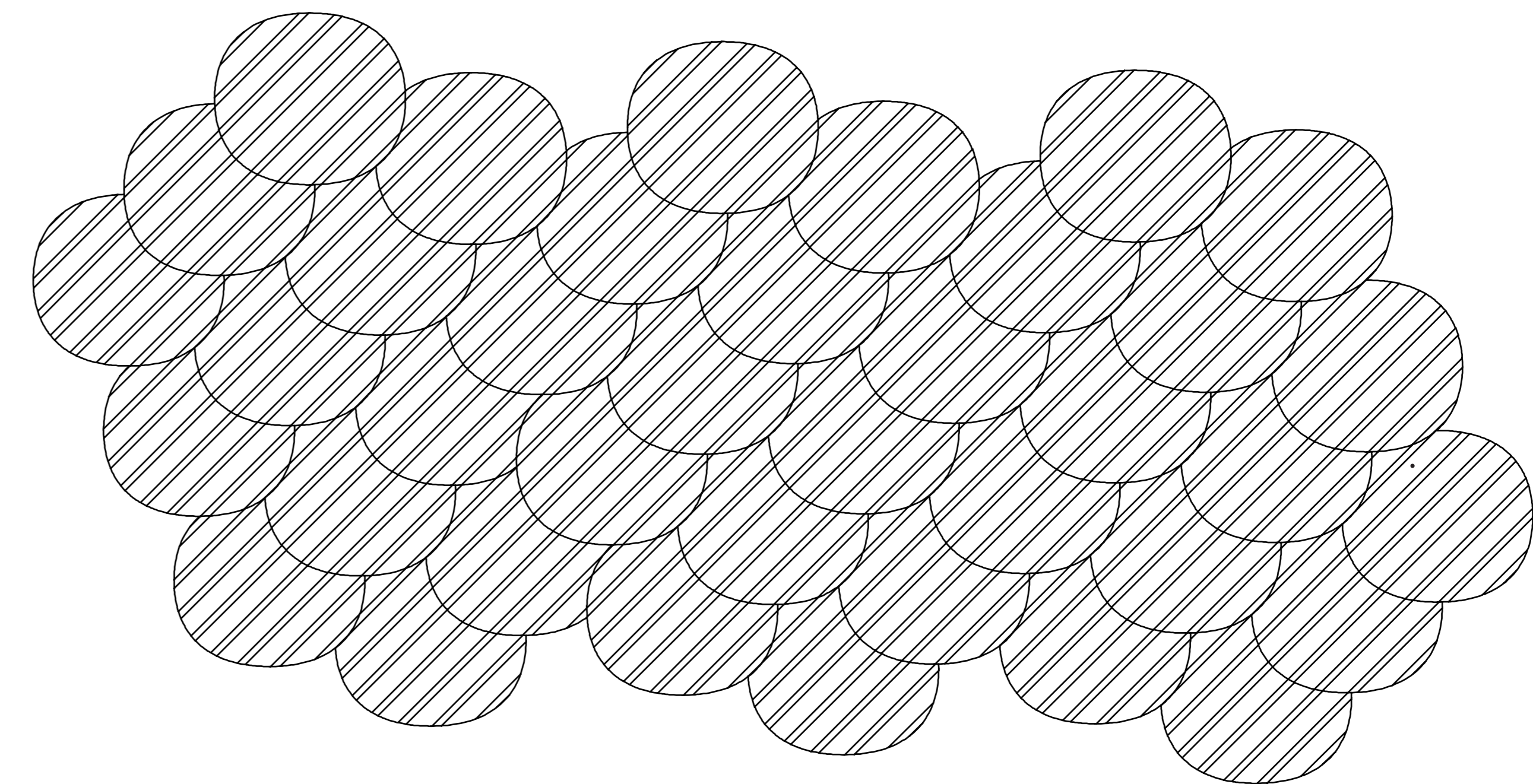

How to prepare and mount your configuration

- 1 Layout**
 - Create your layout with the help of the drawing
- 2 Prepare the wall**
 - Mark the first 2, 3 or 4 centers for the Ondes with this poster
 - Reposition the poster to mark more centers for the Ondes
- 3 Mount the Ondes**
 - Mount the metal plate(s) on the selected center mark(s)
 - Hang the Onde(s). Start with the lowest Onde in your design

Space between the marks

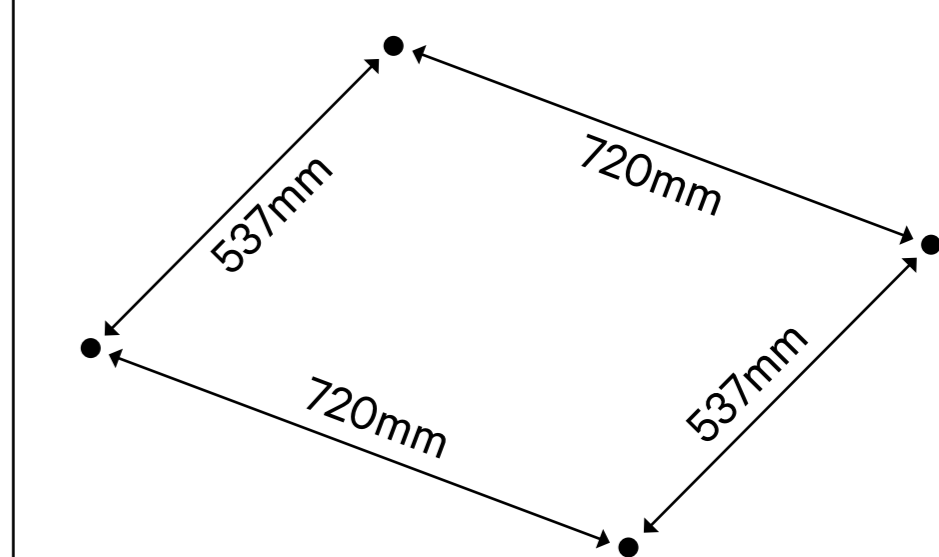

Keep in mind:

- to use the grid
- to place the Onde at a 45 degree angle
- that the Onde is not placed too close to the floor the ceiling or a corner
- that the highest and lowest marking points need 40cm space to be placed correctly
- that left and right marking points need 45cm space

Use the level to balance this sheet

