



---

## BuzziJet Standing 220-240V Product Specification Sheet

---

This document contains technical information about the BuzziJet Standing



[www.buzzi.space](http://www.buzzi.space)

## Perfect Curve

BuzziJet Standing is a simple and stylish add-on to any lounge area or break-out zone. Designed with flexible and open spaces in mind, this sound-absorbing floor lamp brings personality to the space while offering a cosy and calm atmosphere. Its wide upholstered body and aerodynamic design, supported by an elegant curvy frame, will let you experience the importance of good acoustics. Moreover, create a warm and relaxed space through its dimming feature.

Designed by BuzziSpace Studio

---

## General

 Standing

Upholstered acoustic foam shade  
LED disk with opaque diffusor

 Aluminium arch in black (RAL 9005)  
Metal baseplate in black (RAL 9005)  
Fabric power cord in black or red

Wattage: 21W  
Input Voltage: 220-240V  
Input Frequency: 50/60Hz  
Lumen Output: 1900 lumen  
Color Temperature: 3000K  
Color Rendering Index: >95  
Dimming: Floordimmer  
Unified Glare Rating: 22



 IP20 Dry Usage

 Assembled

---

## Acoustics



Absorption



Diffusion



Low tone



Mid tone



High tone

---

## Certifications

CE/CB

---

## Content

Configurations	3	Dimensions	8
Technical components	4	Acoustics	9
Fabrics	5		

# Configurations

---

## BuzziJet Standing

- Upholstered acoustic foam shade
- LED disk with opaque diffusor
- 🌲 Aluminium arch in black (RAL 9005)
- Metal baseplate in black (RAL 9005)
- Fabric power cord in black or red
  
- Total:           Width 187 cm Heigh 211 cm
- ✂ Base:            Ø 65 cm Heigh  2 cm
- Acoustic Shade:  Ø 80 cm Heigh  30 cm
  
- ⚖ Baseplate:     45 kg
- Arch & Shade:  23 kg

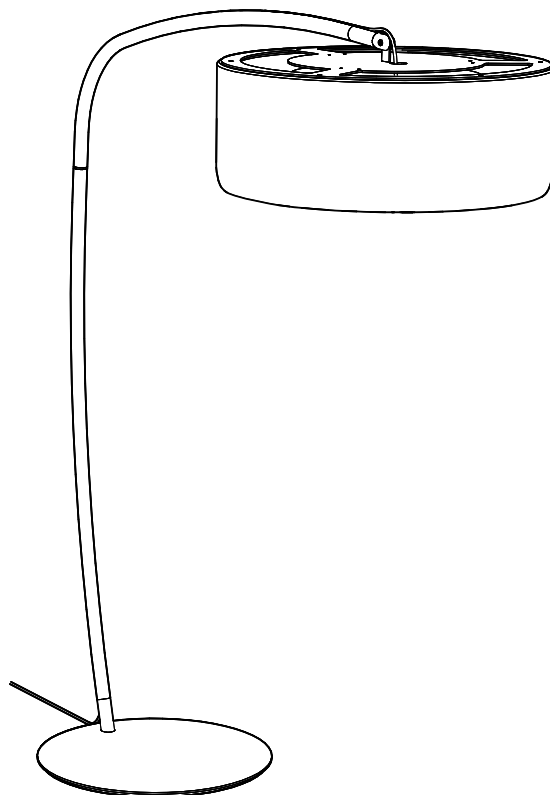

# Technical Components

---

## Light source



The Light source is wrapped with an upholstered ring in the same fabric as the foam shade. The PMMA diffusor ensures an optimal light spread and efficiency. It creates a very diffuse light surface without any dottiness. The light source of the BuzziJet Standing is a LED PCB, containing 36 low power LED's.

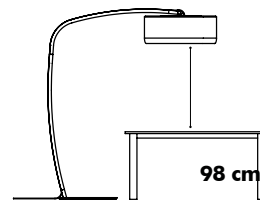

350 Lux

---

## All in details

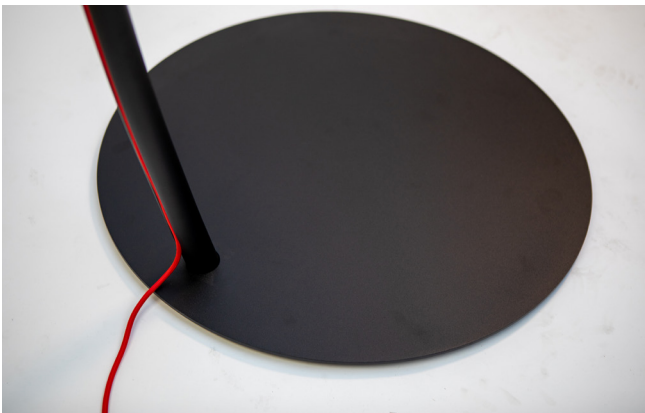

As final touch the fabric cable is intentionally pushed into the curved shape frame, hiding all the screws and connections. Select a red fabric power cable to create a detail that stands out or choose a black one to create an elegant layout.

---

## Dimming



You can choose from a more energized or intimate atmosphere by dimming the light and relax.

# Fabrics

## Fabric

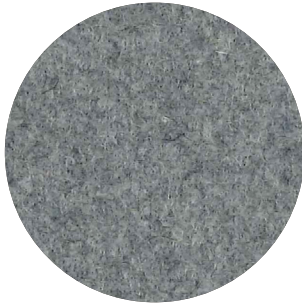

**Category A**

**Composition** 70% Recycled Wool, 25% Recycled Polyacryl,  
5% Recycled Other Fabrics

**Weight** 405 g/m<sup>2</sup> | 11.94 oz/yd<sup>2</sup>

**Abrasion resistance** 40.000 Martindale, 50,000 Wyzenbeek

**Flammability** EU: EN 1021.1/2006 | BS EN 1021.1/2006 (cigarette).  
EN 1021.2/2006 | BS EN 1021.2/2006 (match)  
USA: CAL TB 117 | ASTM E84 CLASS A

**Fastness to light** EU: 4 | USA 4

**Fastness to rubbing** EU: Wet 3-4 | Dry 4-5

**Fastness to crocking** USA: Wet 5 | Dry 5



## Trevira CS+ | CS

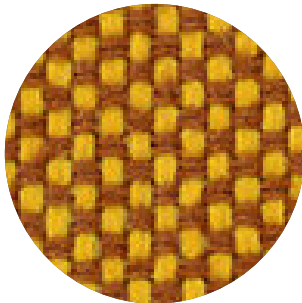

**Category A**

**Weight** 420 g/m<sup>2</sup> | 12.39 oz/yd<sup>2</sup>

**Composition** 100% Polyester, Trevira CS

**Abrasion resistance** 100.000 Martindale, 90,000 Wyzenbeek

**Flammability** BS 5852 part II: CRIB 5 | BS 7176 Medium Hazard  
USA: CAL TB 117 | M1 | B1 | EN 1021/1-2 | C1 |  
IMO Res. A652 (16)

**Fastness to light** EU: 6 | USA 5

**Fastness to rubbing** EU: Wet 4-5 | Dry 4-5

**Fastness to crocking** USA: Wet 5 | Dry 5



## Revive 1

kvadrat

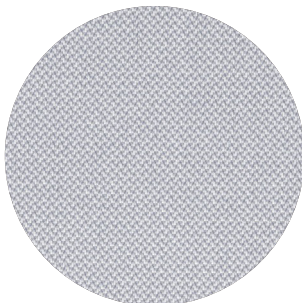

**Category A**

**Composition** 100% recycled polyester FR

**Weight** 430 g/lin.m

**Abrasion resistance** 60.000 Martindale rubs, EN ISO 12947

**Flammability** EN 1021-1/2 | DIN 4102 B1 | Önorm B1/Q1  
UNI 9175 1IM | US Cal. Tech. Bull. 117  
IMO A.652 (16)

**Fastness to light** Note 5-7, ISO 105-B02

**Fastness to rubbing** (ISO) dry 5, wet 4-5

**Pilling** Note 4-5, EN ISO 12945



## Clara 2

kvadrat

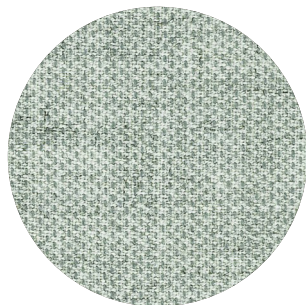

**Category** B

**Composition** 92% new wool, 8% nylon

**Weight** 400 g/lin.m

**Abrasion resistance** 80.000 Martindale rubs, EN ISO 12947

**Flammability** EN 1021-1/2 | BS 5852, ignition source 2-3 | DIN 4102 B2  
NF D 60 013 | UNI 9175 11M | US Cal. Tech. Bull. 117, Sec. E  
NFPA 260 | IMO A.652(16)

**Fastness to light** Note 5-7, ISO 105-B02

**Fastness to rubbing** (ISO) dry 4-5, wet 4

**Pilling** Note 4, EN ISO 12945



## Remix 3

kvadrat



**Category** B

**Composition** 90% new wool, 10% nylon

**Weight** 415 g/lin.m

**Abrasion resistance** 100.000 Martindale rubs, EN ISO 12947

**Flammability** EN 1021-1/2 | BS 5852 part 1  
Önorm B1/Q1 | NF D 60 013 | UNI 9175, 11M  
AS/NZS 1530.3 | Cal. Tech. Bull. 117-2013  
NFPA 260 | IMO FTP Code 2010:Part 8

**Fastness to light** Note 5-7, ISO 105-B02

**Fastness to rubbing** (ISO) dry 4-5, wet 4

**Pilling** Note 4, EN ISO 12945



## Hero

kvadrat

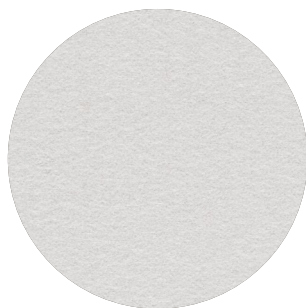

**Category** C

**Composition** 96% new wool, 4% nylon

**Weight** 580 g/lin.m

**Abrasion resistance** 45.000 Martindale rubs, EN ISO 12947

**Flammability** EN 1021-1/2 | DIN 4102 B2 | NF D 60 013  
UNI 9175 11M | US Cal. Bull. 117-2013 | NFPA 260  
IMO A.652 (16)

**Fastness to light** Note 5-6, ISO 105-B02

**Fastness to rubbing** (ISO) dry 4-5, wet 4-5

**Pilling** Note 3-4, EN ISO 12945



## Tonus 4

kvadrat

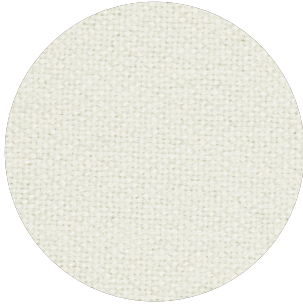

**Category** D

**Composition** 90% new wool, 10% Helanca

**Weight** 665 g/lin.m

**Abrasion resistance** 100.000 Martindale rubs, EN ISO 12947

**Flammability** EN 1021-1/2 | BS 5852 part 1 | DIN 4102 B2

Önorm B1/Q1 | NF D 60 013 | UNI 9175 11M

US Cal. Bull. 117-2013 | NFPA 260 | IMO A.652 (16)

**Fastness to light** Note 5-7, ISO 105-B02

**Fastness to rubbing** (ISO) dry 3-5, wet 3-5

**Pilling** Note 3, EN ISO 12945



## Memory 2

kvadrat

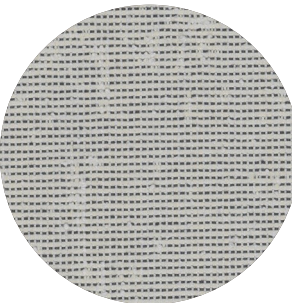

**Category** E

**Composition** 100% Trevira CS

**Weight** 700 g/lin.m

**Abrasion resistance**

35.000 rubs acc. to the Martindale method, EN ISO 12947

**Flammability** EN 1021-1/2 | DIN 4102 B1 | Önorm B1/Q1

NF D 60 013 | NF P 92 507 M1 | UNI 9175 11M

UNI 9177 classe 1 | US Cal. Tech. Bull. 117

IMO A.652 (16)

**Fastness to light** Note 5-8, ISO 105-B02

**Fastness to rubbing** (ISO) dry 4-5, wet 4-5

**Pilling** Note 4, EN ISO 12945



# Dimensions

## BuzziJet Standing

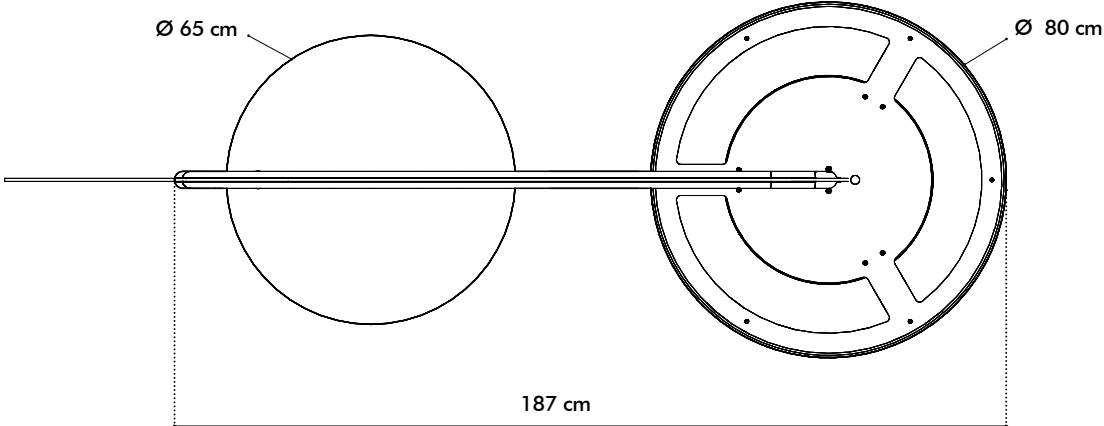
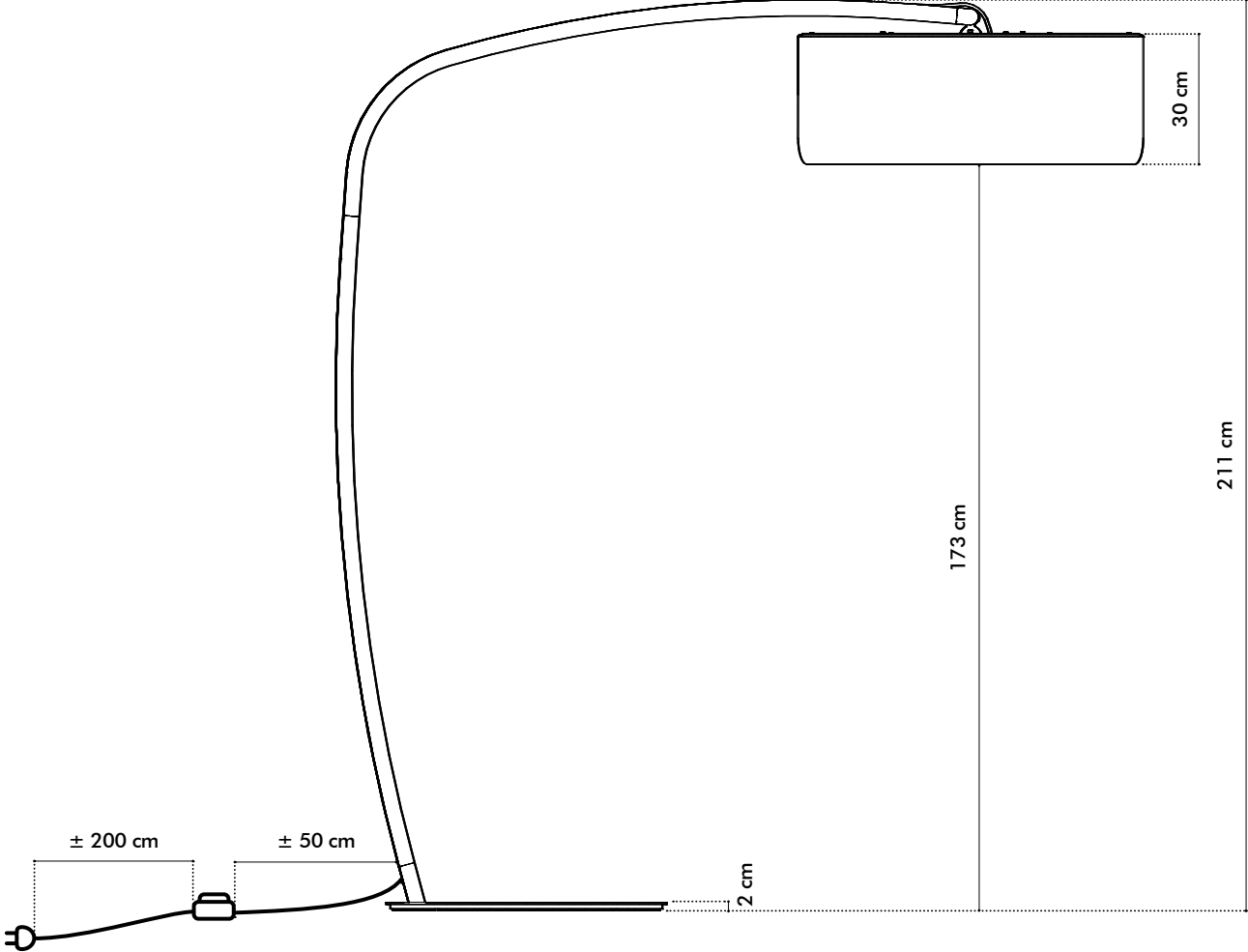



# Acoustics

---

## BuzziJet Standing

Equivalent sound absorption area in m<sup>2</sup> per object

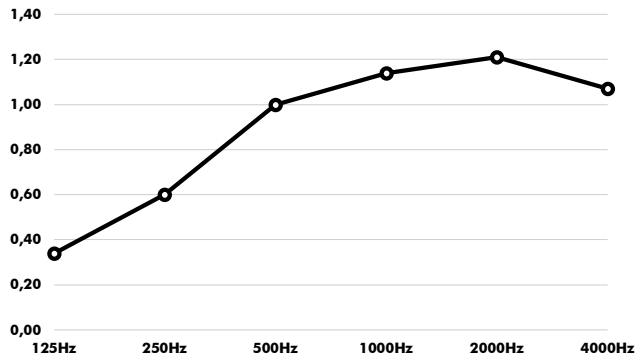

Hz	Aeq/m <sup>2</sup>
125	0.34
250	0.60
500	1.00
1000	1.14
2000	1.21
4000	1.07