BuzziChandelier

220-240V

Product Specification Sheet

This document contains technical information about the BuzziChandelier



www.buzzi.space









An eye-catching lighting solution

Make a statement with your lighting by opting for the BuzziChandelier.

A contemporary take on the classic chandelier. The perfect way to add atmosphere to your room with artful shadows and softened sounds. BuzziChandelier is an ideal design statement and acoustical solution for offices, restaurants, hotels, institutions, residences and more.

Design by Sas Adriaenssens

General

-  Ceiling Suspended
- Cover in BuzziFelt
-  3 metal suspension cables
- Powder coated metal frame in Black (RAL 9005)
- Black fabric power cord
- 220-240V 50/60Hz Class 1
-  2G11 fitting
- Max. 55 W
-  IP20 Dry usage
-  W Ø 78 cm H 75 cm
- W Ø 30.71" H 29.53"
-  10,5 kg
- 27.56 lbs
-  Fixing System Screw with 3 cables of 2 m - 78.74" or 5 m - 196.85" in Black or Alu color
-  Assembled
-  If installing on suspended ceiling, verify load capacity prior to installation.

Certifications



Acoustics



Absorption



Diffusion



Mid tone



High tone

Content

Configurations	3	Fabrics	5
Composition	4	Dimensions	6

Configurations

BuzziChandelier

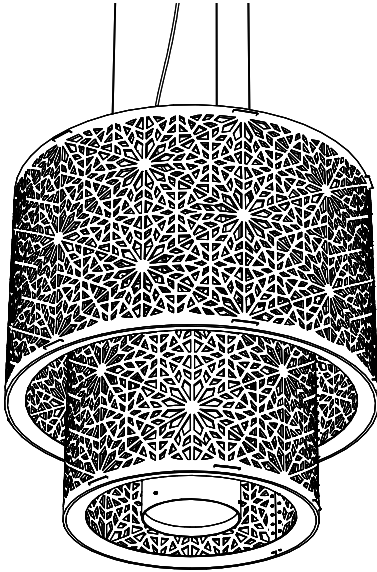

- ◆ Ceiling Suspended
- ◆ Cover in BuzziFelt with push snaps
- ◆ 3 metal suspension cables
- ◆ Powder coated metal frame in Black (RAL 9005)
- ◆ Black fabric power cord

- ✂ W Ø 78 cm H 75 cm
W Ø 30.71" H 29.53"

- ⚖ 10,5 kg
27.56 lbs

- ⋮ Fixing System Screw with 3 cables of 2 m - 78.74" or 5 m - 196.85" in Black or Alu color

BuzziChandelier printed

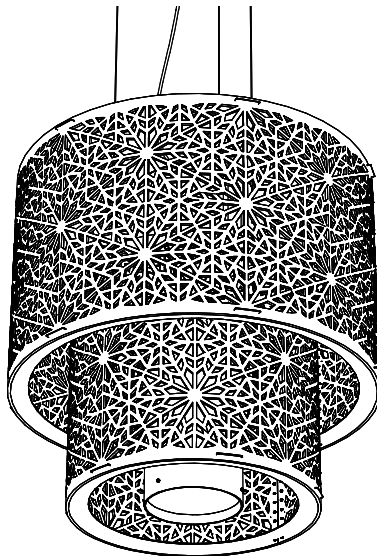

- ◆ Ceiling Suspended
- ◆ Cover in OffWhite BuzziFelt printed (outside) in Gold, Emperador or Carrara with push snaps
- ◆ 3 metal suspension cables
- ◆ Powder coated metal frame in Black (RAL 9005)
- ◆ Black fabric power cord

- ✂ W Ø 78 cm H 75 cm
W Ø 30.71" H 29.53"

- ⚖ 10,5 kg
27.56 lbs

- ⋮ Fixing System Screw with 3 cables of 2 m - 78.74" or 5 m - 196.85" in Black or Alu color

BuzziChandelier plain

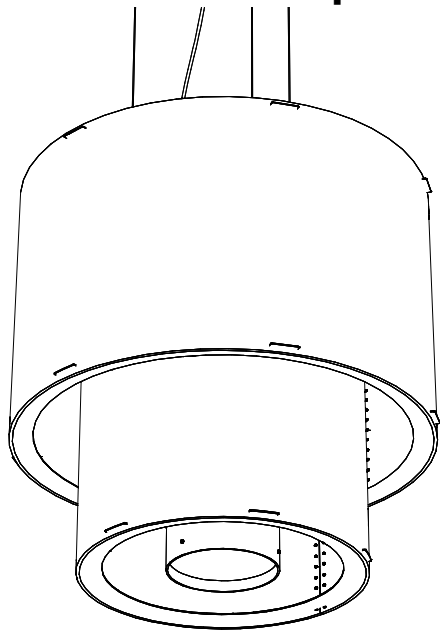

- ◆ Ceiling Suspended
- Cover in BuzziFelt with push snaps
- ◆ 3 metal suspension cables
- Powder coated metal frame in Black (RAL 9005)
- Black fabric power cord
- ✕ W Ø 78 cm H 75 cm
W Ø 30.71" H 29.53"
- ⚖ 10,5 kg
27.56 lbs
- ⋮ Fixing System Screw with 3 cables of 2 m - 78.74" or 5 m - 196.85" in Black or Alu color

BuzziChandelier plain printed

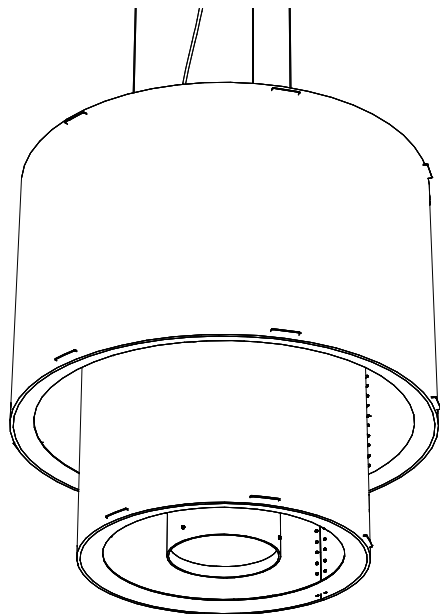

- ◆ Ceiling Suspended
- Cover in OffWhite BuzziFelt printed (outside) in Gold, Emperador or Carrara with push snaps
- ◆ 3 metal suspension cables
- Powder coated metal frame in Black (RAL 9005)
- Black fabric power cord
- ✕ W Ø 78 cm H 75 cm
W Ø 30.71" H 29.53"
- ⚖ 10,5 kg
27.56 lbs
- ⋮ Fixing System Screw with 3 cables of 2 m - 78.74" or 5 m - 196.85" in Black or Alu color

Composition

Ceiling canopy and power cord



Powder coated metal canopy in Black (RAL 9005)
Including mounting bracket
Height: 2,6 cm | 1.02"
Diameter: 12 cm | 4.72"

CFL Bulb



55 W 4 pin CFL Bulb with 2G11 base included
Not dimmable

Fabrics

Felt

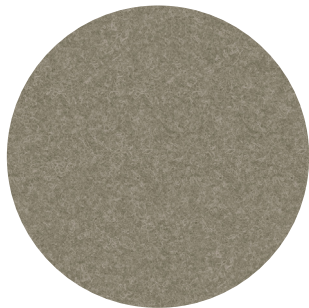

Composition 100% Recycled PE.T. Felt
Weight 1.000 g/m2 | 29.49 oz/yd2
Abrasion resistance >7.000 Martindale
Flammability EU: EN 13501.1+A1/2009
BS476 Part 6 and 7 Class 0
USA: ASTM E84 Class A certified
Fastness to light USA 5



Felt OffWhite Printed

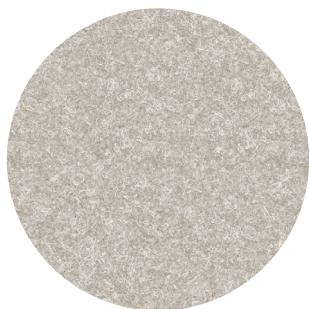

Composition 100% Recycled PE.T. Felt
Weight 1.000 g/m2 | 29.49 oz/yd2
Abrasion resistance >7.000 Martindale
Flammability EU: EN 13501.1+A1/2009
BS476 Part 6 and 7 Class 0
USA: ASTM E84 Class A certified
Fastness to light USA 5



Gold

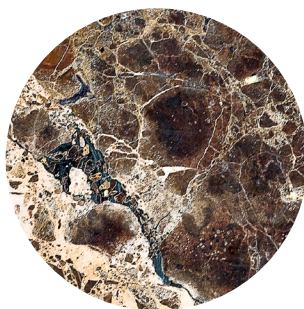

Emperor



Carrara

Dimensions

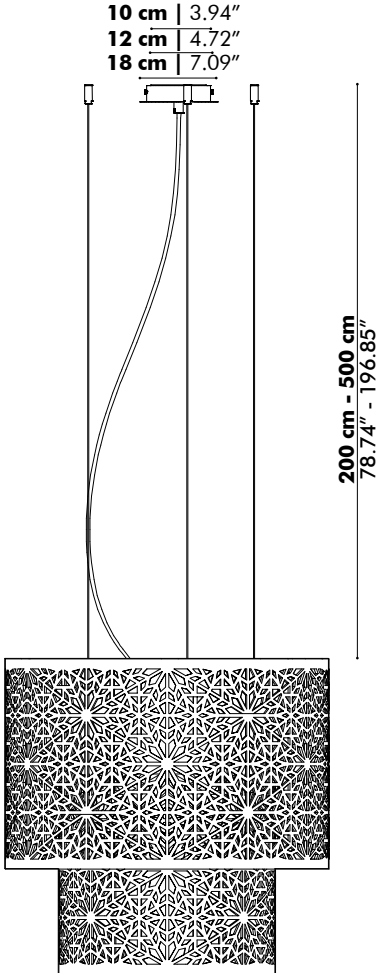
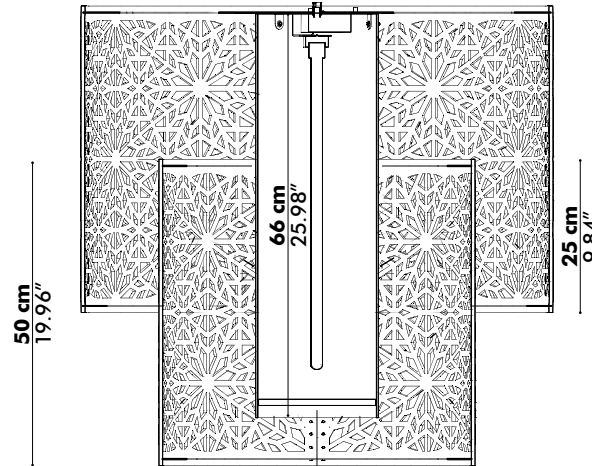
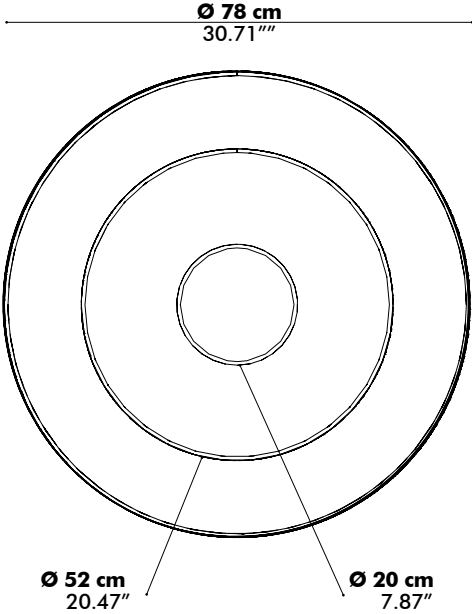
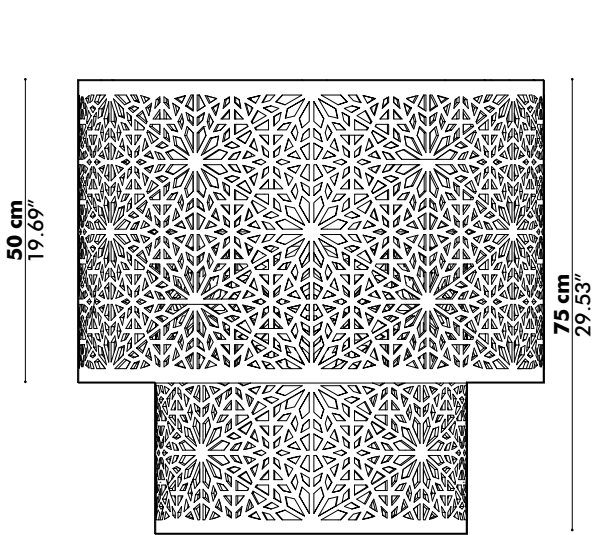

Acoustics

BuzziChandelier

Equivalent sound absorption area in m² per object

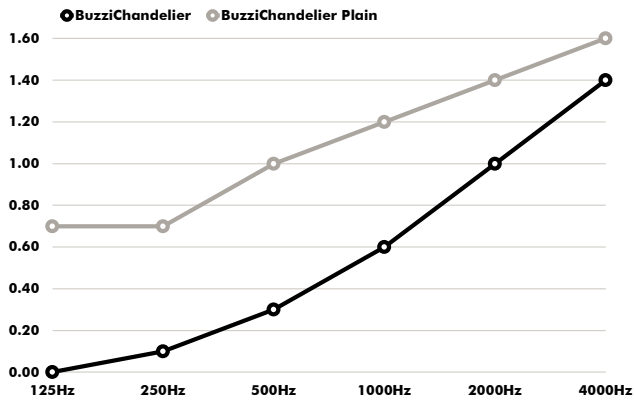

Hz	Aeq/m ²	Plain Aeq/m ²
125	0,0	0,7
250	0,1	0,7
500	0,3	1
1000	0,6	1,2
2000	1,0	1,4
4000	1,4	1,6